

SERIAL No. / PRODUCT No. GUIDE

| | |
|-------------------------------|---|
| SERIAL#XXXXXXXX | Serial n°, Serijski broj, Партиден номер, Sériové číslo, Seriennummer, Serie nummer, Seerianumber, Sarjanumero, Numéro de série, Sorozatszám, Serijos numeris, Sērijas numurs, Seriennummer, Număr de serie, Серийный номер, Sériové číslo, Seriennummer, Seri numarasi, Seriennummer, Número de serie, Numero di serie, Numer seryjny, Série n°, Serijski broj, Serijski broj, Serijska številka, Σειριακός αριθμός |
| #XXXXX ----- #PXXXXX | Product n°, Broj proizvoda, Модел, číslo produktu, Artikelnummer, Product nummer, Tootenumber, Tuotenumero, Numéro de produit, Termék száma, Gaminio numeris, Produkta numurs, Artikkelnummer, Numărul produsului, Код товара, číslo výrobku, Artikelnummer, Ürün numarası, Produktnummer, Número de producto, Codice prodotto, Numer produktu, Produto n°, Proizvod broj, Broj proizvoda, Izdelek števi |
| YYYY-MM-DD ----- DDMMYY | Production date, Datum proizvodnje, Дата на производство, Datum výroby, Produktionsdato, Productie datum, Tootmisnumber, Tuotantopäivä, Date de production, Gyártás időpontja, Pagaminimo data, Ražošanas datums, Produksjonsdato, Data fabricației, Дата производства, Dátum výroby, Produktionsdatum, Üretim tarihi, Herstellungsdatum, Fecha de fabricación, Data di produzione, Data produkcji, Data de produção, Datum proizvodnje, Datum proizvodnje, Datum proizvodnje, Ημερομηνία παραγωγής |

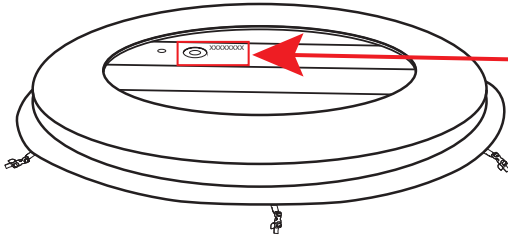

XXXXXXXXXXXXX
#XXXXXXX
YYYY-MM-DD/DDMY

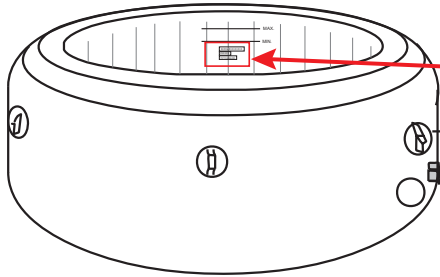

— MAX.
— MIN.
SERIAL#XXXXXXXXX
#XXXXX
YYYY-MM-DD/DDMY

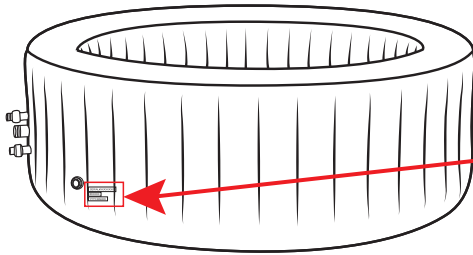

1 SERIAL#XXXXXXXXX
#XXXXX
YYYY-MM-DD/DDMY

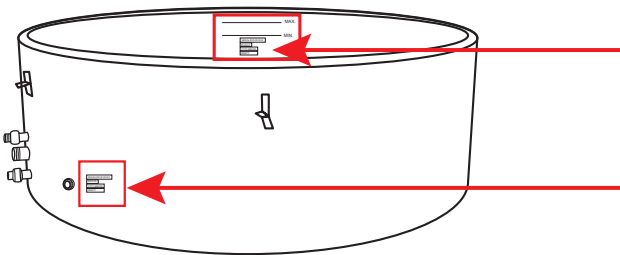

— MAX.
— MIN.
SERIAL#XXXXXXXXX
#XXXXX
YYYY-MM-DD/DDMY

1
SERIAL#XXXXXXXXX
#XXXXX
YYYY-MM-DD/DDMY

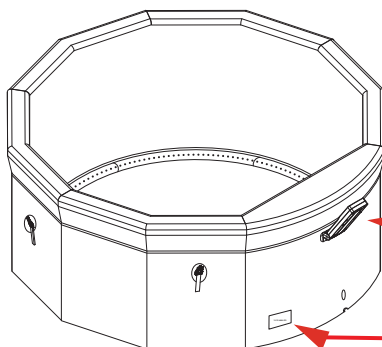

#PXXXXX

XXXXXXXXXXXXX
YYYY-MM-DD/DDMY

1 SERIAL#XXXXXXXXX
#XXXXX
YYYY-MM-DD/DDMY

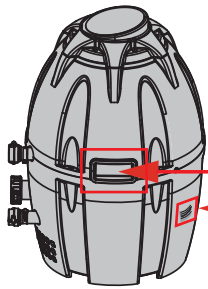

YYYY-MM-DD

#XXXXXX

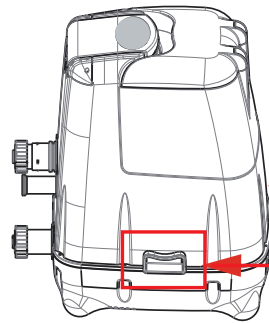

#PXXXXX

XXXXXXXXXX

YYYY-MM-DD/DDMY

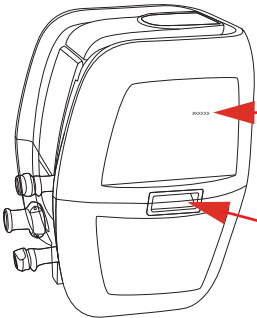

#XXXXXX

YYYY-MM-DD/DDMY

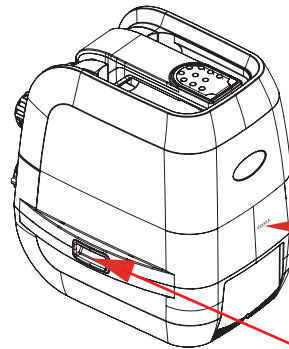

#PXXXXX

XXXXXXXXXX

YYYY-MM-DD/DDMY

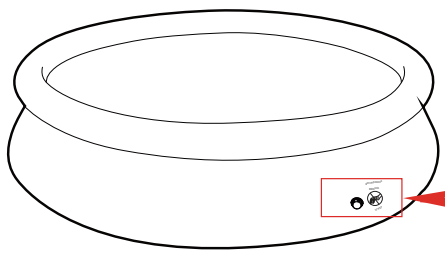
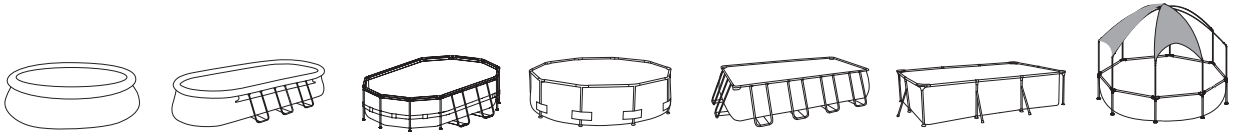

SERIAL#XXXXXXXXX
 #XXXXXXXXXXXXX
 YYYY-MM-DD/DDMY
 10'X30"
 

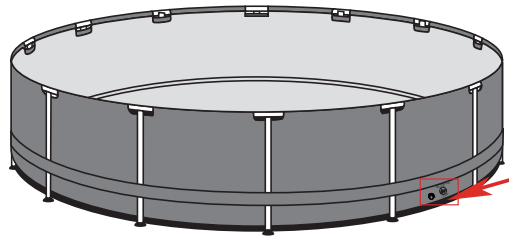

SERIAL#XXXXXXXXX
 #XXXXXXXXXXXXX
 YYYY-MM-DD/DDMY
 15'X48"
 

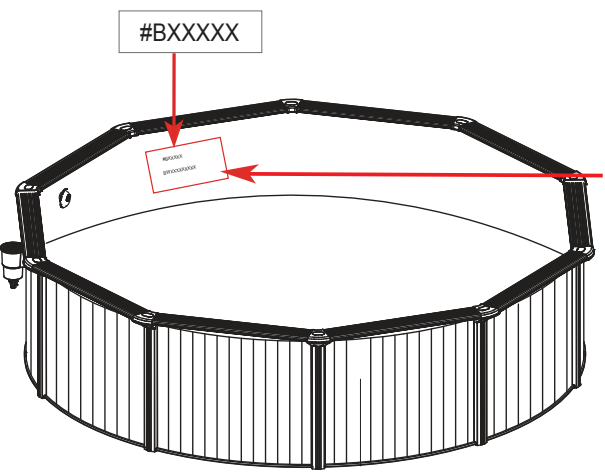

#BXXXXX

SERIAL#XXXXXXXXX
 #XXXXXXXXXXXXX
 YYYY-MM-DD/DDMY

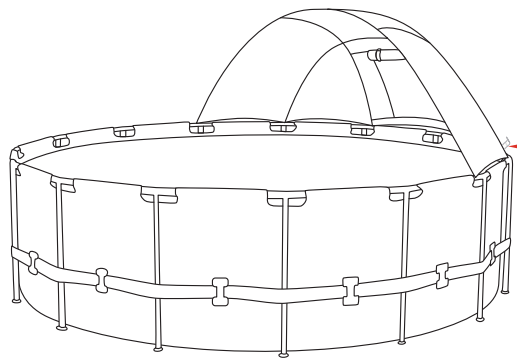

YYYY-MM-DD/DDMY

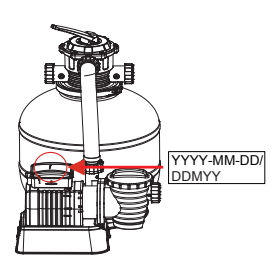
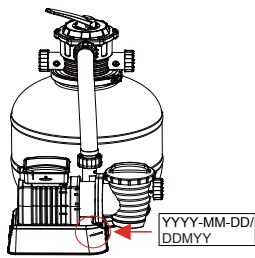
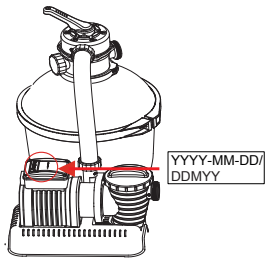
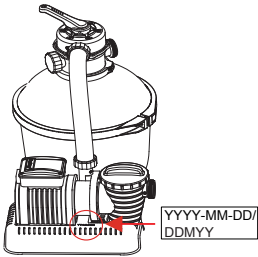
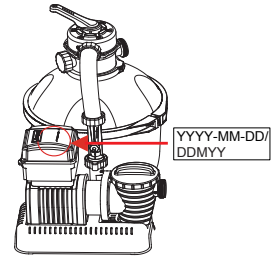
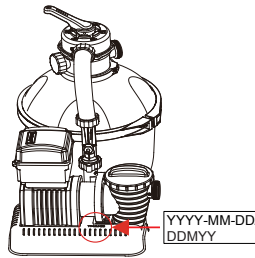
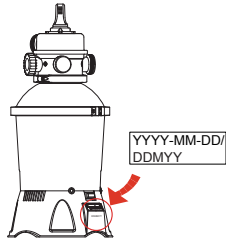
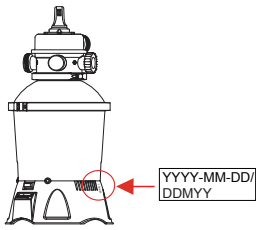
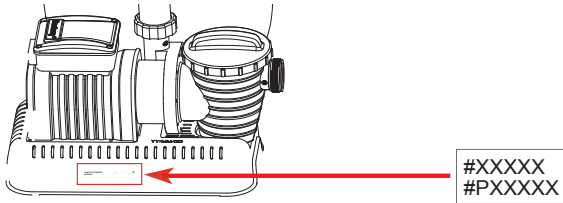
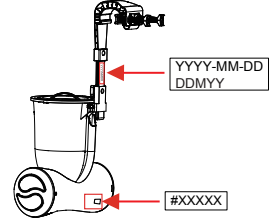
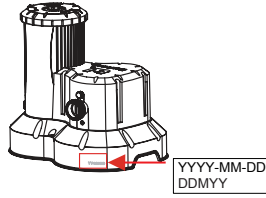
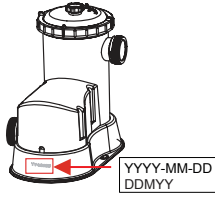
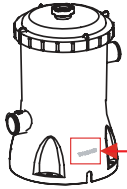
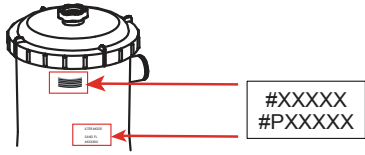

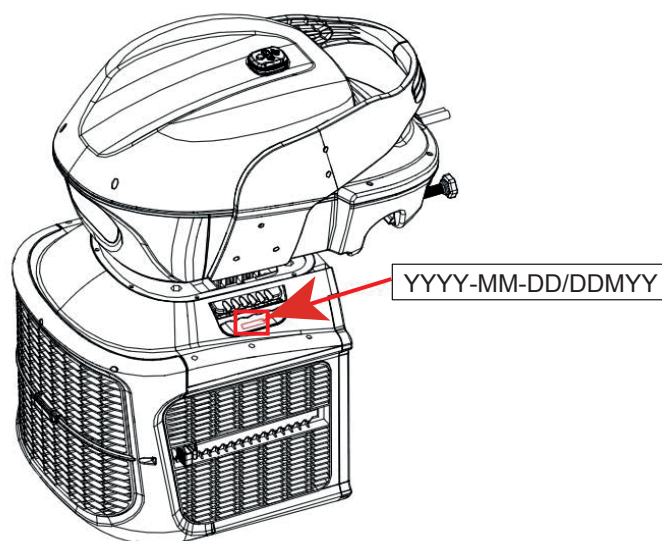
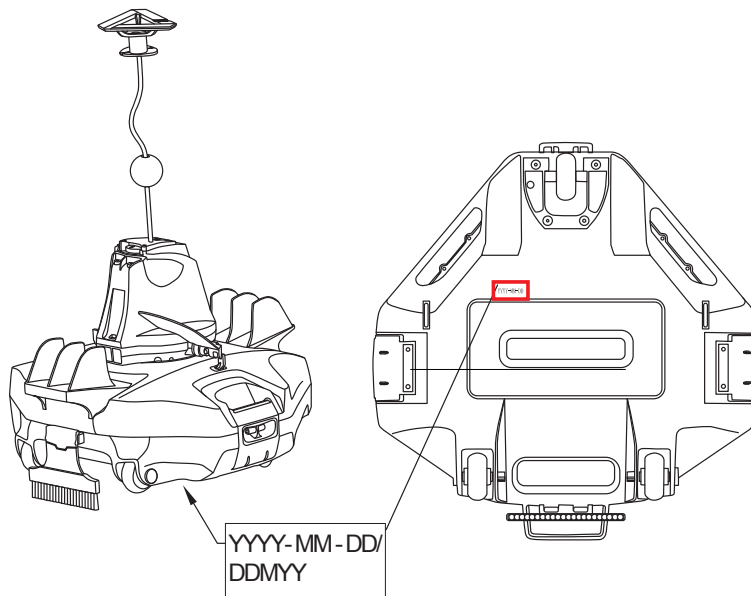
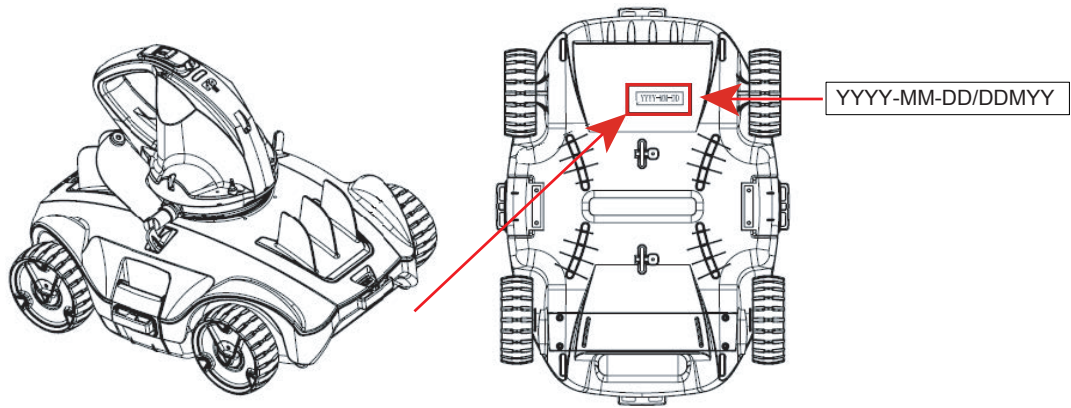

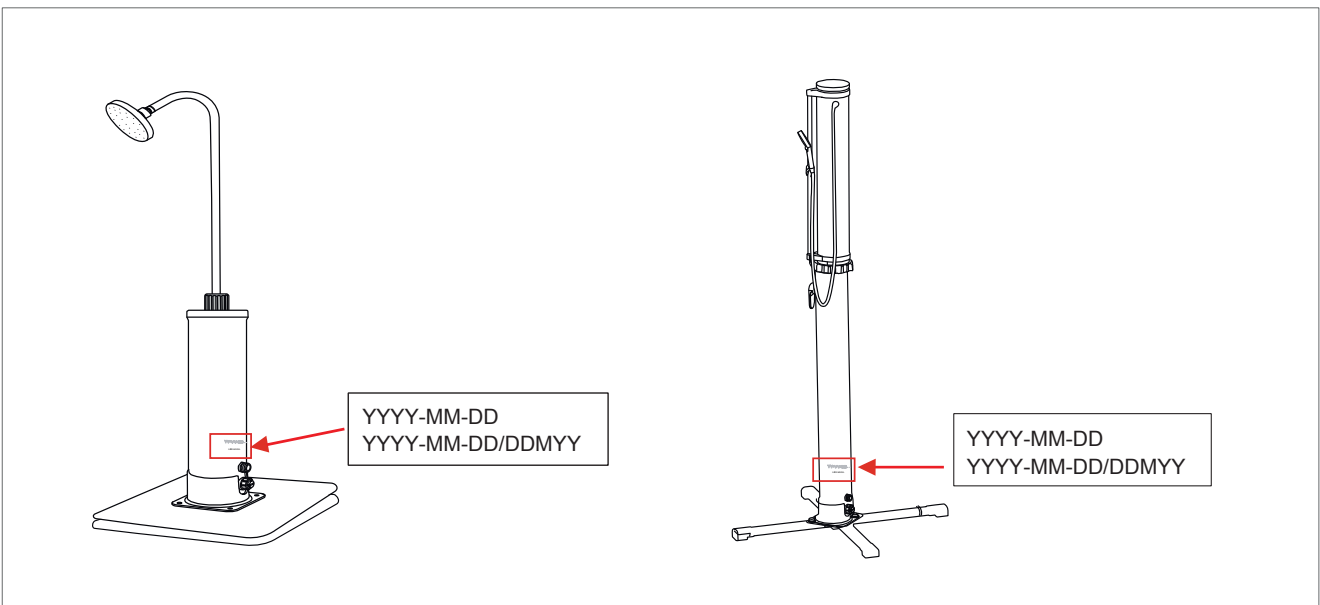
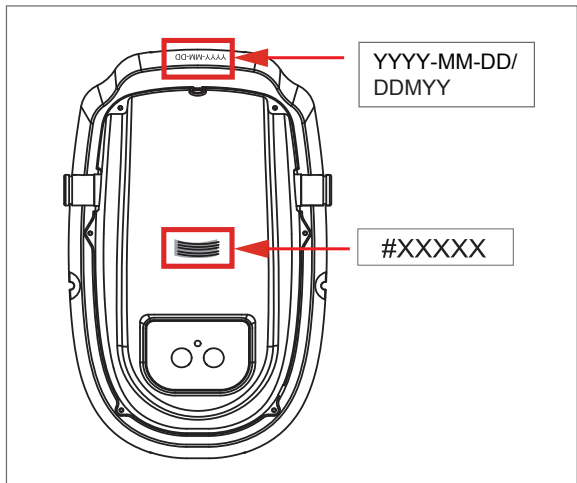
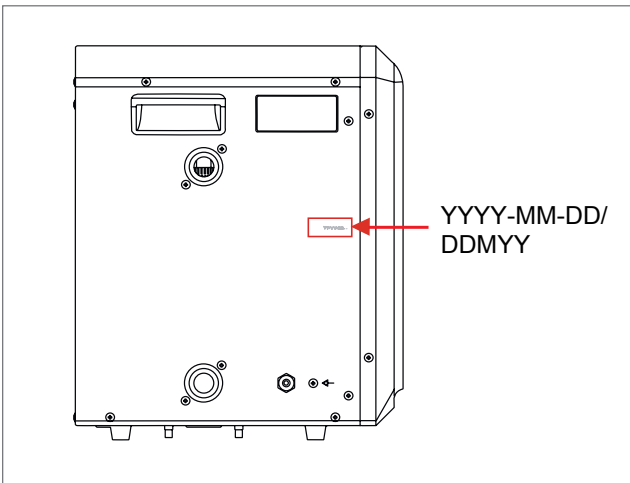
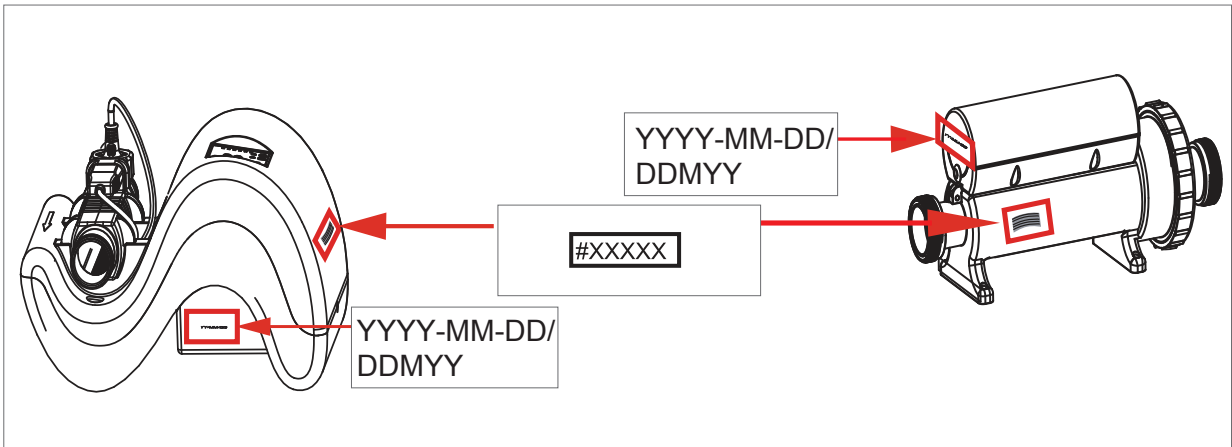



XXXXXXXX
DDMY

XXXXXXXX
YYYY-MM-DD

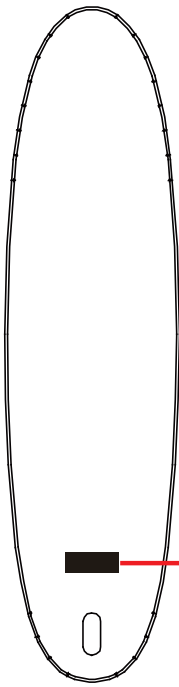

XXXXXXXX
DDMY

XXXXXXXX
YYYY-MM-DD